



Reliance Industries, LLC

**Installation, Operation, Inspection and Maintenance
Instructions for the Vertical Ladder Stanchion Davit &
Receptacle**

Part Number 6514 & 6515



**Reliance Industries, LLC
PO Box 2046
Deer Park, TX 77536
Ph. (888) 362-2826
Ph. (281) 930-8000
Fax (281) 930-8666**

User Instructions

6514 & 6515 Vertical Ladder Stanchion Davit & Receptacle



Reliance Industries, LLC

Important Instructions!

These instructions must be kept on file and available for the users reference at **all** times. The users must read and full understand these instructions or have the instructions explained in detail before using this equipment.

Failure to observe these instructions could result in serious injury or death.

Prior to use, all workers must be trained in the proper use of all systems and equipment.

A Training and Instruction review should be repeated at regular intervals.

A rescue plan must be prepared; the workers must be trained in its use, and rescue equipment must be on hand prior to any use of this Vertical Ladder Stanchion system.

Any questions regarding these instructions should be directed to:

Reliance Industries, LLC
PO Box 2046
Deer Park, TX 77536
USA
Tel.: (281) 930-8000
Tel.: (888) 362-2826
Fax: (281) 930-8666
E-mail: Info@reliable.com

User Instructions

6514 & 6515 Vertical Ladder Stanchion Davit & Receptacle



Reliance Industries, LLC

Table of Contents

IMPORTANT INSTRUCTIONS! 2

IMPORTANT OSHA REGULATIONS COVERING THE DESIGN OF FIXED METAL LADDERS..... 4

THE MINIMUM CLEAR LENGTH OF RUNGS OR CLEATS SHALL BE 16 INCHES. 4

SYSTEM DESCRIPTION 5

ANCHORAGE POINTS 5

MATERIALS OF CONSTRUCTION..... 5

VERTICAL LADDER STANCHION RECEPTACLE & DAVIT COMPONENTS 6

 FIG. 1 COMPONENTS OF THE VERTICAL LADDER STANCHION RECEPTACLE & DAVIT..... 6

PERSONAL FALL ARREST EQUIPMENT USED WITH THE VERTICAL LADDER STANCHION RECEPTACLE & DAVIT..... 7

INSTALLATION LAYOUT CONSIDERATIONS..... 7

 FIG. 2 7

INSTALLATION 8

VERTICAL LADDER STANCHION RECEPTACLE & DAVIT INSTALLATION PROCEDURES..... 8

 TO INSTALL THE VERTICAL LADDER STANCHION RECEPTACLE & DAVIT 8

 FIG. 5 9

 FIG. 4 9

 FIG. 3 9

 FIG. 6 9

 FIG. 7 10

 CONNECTING AN SRL TO THE VERTICAL LADDER STANCHION 10

 FIG. 9 10

 FIG. 8 10

TRAINING..... 11

PLANNING FOR RESCUE..... 11

INSPECTION..... 12

SERVICING 12

WARNINGS AND LIMITATIONS 13

INSPECTION LOG FOR THE VERTICAL LADDER STANCHION..... 14

User Instructions

6514 & 6515 Vertical Ladder Stanchion Davit & Receptacle



Reliance Industries, LLC

Important OSHA Regulations Covering the Use of Fall Arrest Anchorage Systems

OSHA 1926.502 (d)(15):

Anchorage used for attachment of personal fall arrest equipment shall be independent of any anchorage being used to support or suspend platforms and capable of supporting at least 5,000-lb (22 kN) per employee attached, or shall be designed, installed, and used as follows:

(d)(15)(i):

as part of a complete personal fall arrest system which maintains a safety factor of at least two; and

(d)(15)(ii):

under the supervision of a qualified person.

OSHA 1926.502 (d)(16)(iii):

Personal fall arrest systems shall be rigged such that an employee can neither free-fall more than 6-ft. nor contact any lower surface.

OSHA 1926.502 (d)(21):

Personal fall arrest systems shall be inspected prior to each use for wear, damage and other deterioration, and defective components shall be removed from service.

OSHA 1926.502 (d)(19):

Personal fall arrest systems and components subjected to impact loading shall be immediately removed from service and shall not be used again for employee protection until inspected and determined by a competent person to be undamaged and suitable for reuse.

Important OSHA Regulations Covering the Design of Fixed Metal Ladders

OSHA 1910.27 (b)(1)(i):

All rungs shall have a minimum diameter of three-fourths inch for metal ladders,

OSHA 1910.27 (b)(1)(ii):

The distance between rungs, cleats, and steps shall not exceed 12 inches and shall be uniform throughout the length of the ladder.

OSHA 1910.27 (b)(1)(ii):

The minimum clear length of rungs or cleats shall be 16 inches.

User Instructions

6514 & 6515 Vertical Ladder Stanchion Davit & Receptacle



Reliance Industries, LLC

System Description

The Vertical Ladder Stanchion Receptacle & Davit are one component of a personal fall arrest system that is designed to anchor a self-retracting lifeline (SRL) that a single worker can use to climb or descend a fixed metal ladder. The Ladder Stanchion uses adjustable rung clamps to attach the Stanchion to any OSHA standard ladder. Once installed, an SRL with a Maximum Arrest Force (MAF) of 900-lb. may be attached to the head assembly of the Stanchion providing fall protection for a single individual. NOTE: Only one 6514 and 6515 Ladder Stanchion Davit and Receptacle can be attached to any one ladder; connecting more than one Receptacle to a ladder at a time could exceed the rated strength of the ladder.

This anchorage is one component of a personal fall arrest system. The system is used in conjunction with a full-body harness for the worker and a self-retracting lanyard (SRL) with 900-lb. Maximum Arrest Force (MAF) using double-action single-locking snap hooks to attach to the dorsal D-ring of the harness. Shock absorbing lanyards and retractables that do not have "slip-clutch" type internal shock absorbers with a 900 lb. maximum MAF are **NOT** allowed for use as vertical lifelines to attach to this Vertical Ladder Stanchion Receptacle & Davit. Any attachments to the Ladder Stanchion Receptacle & Davit must transfer fall arrest forces to the body through the dorsal d-ring of the full body harness only. Harness side and chest d-rings are not allowable connection points.

Anchorage Points

The Vertical Ladder Stanchion Receptacle & Davit is designed to be attached to an OSHA compliant fixed ladder. These ladders are metal consisting of rungs at least $\frac{3}{4}$ -in. in diameter, a minimum of 16-in. wide, and be uniformly spaced no more than 12-in. vertically (per OSHA 1910.27). The ladder must be vertical and affixed to an appropriate structure capable of supporting the ladder and the loads it was designed to carry. If there are questions concerning the suitability of a ladder for anchoring a Vertical Ladder Stanchion to, please contact Reliance Industries at 303-424-8650 prior to use.

Materials of Construction

Ladder Stanchion Davit Tube: Zn plated steel

Ladder Stanchion Receptacle Tube: Zn plated steel

Rung Clamps: Zn plated steel

Bolts, washers and nuts: Zn plated steel

User Instructions

6514 & 6515 Vertical Ladder Stanchion Davit & Receptacle



Reliance Industries, LLC

Vertical Ladder Stanchion Receptacle & Davit Components

The Vertical Ladder Stanchion Receptacle & Davit consists of the following standard approved and compatible components:

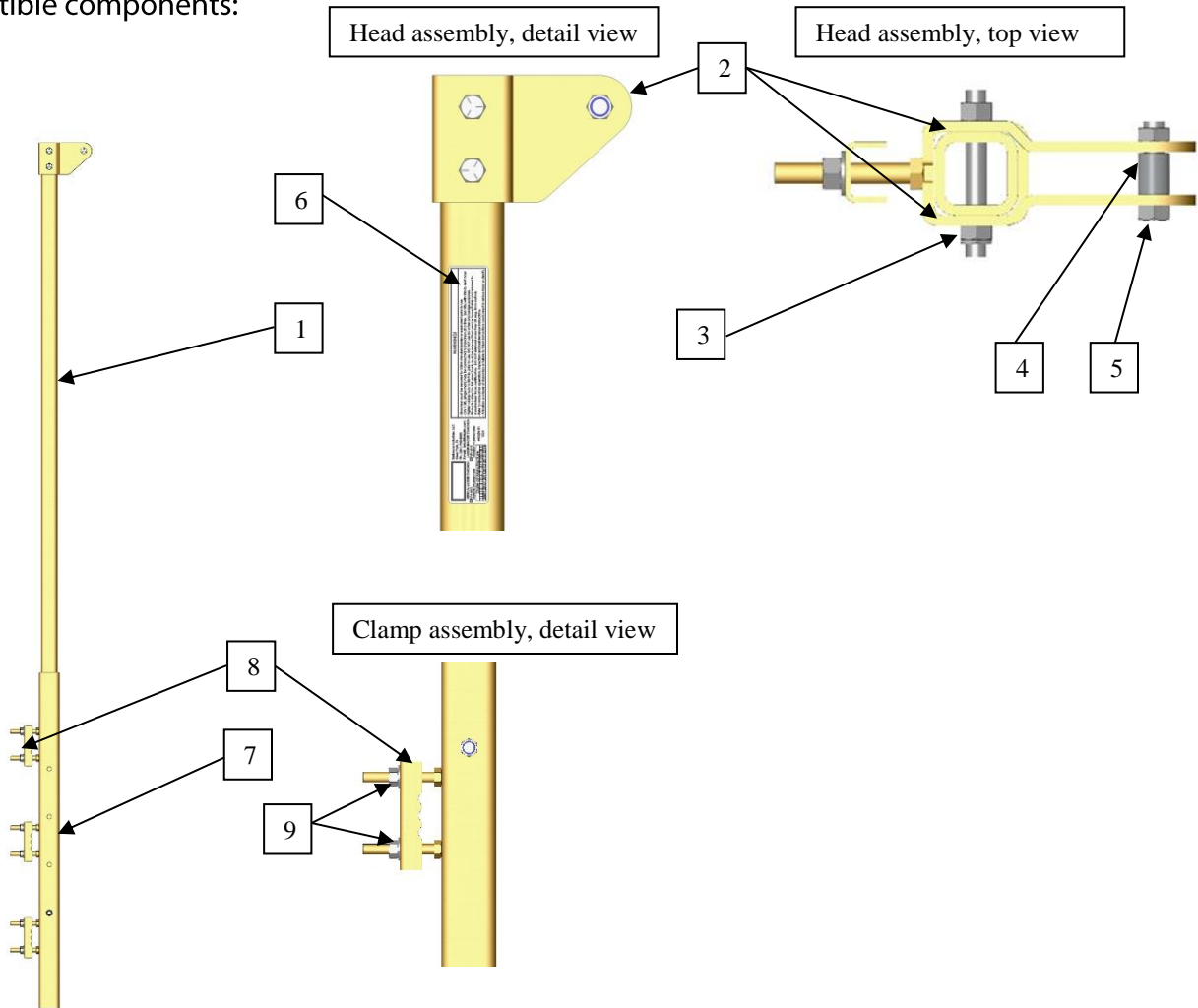

Fig. 1 Components of the Vertical Ladder Stanchion Receptacle & Davit

1. Ladder Stanchion Davit Tube, 1 ea.
2. Head Sideplates, 2 ea.
3. Head bolt and nut, 2 sets.
4. Head Spacer, 1 ea.
5. Spacer bolt and nut, 1 sets
6. Label, 2 ea.
7. Ladder Stanchion Receptacle Tube, 1 ea.
8. Rung Clamp, 3 ea.
9. Flat & lock Washer, nylock nut, 6 sets.
10. Davit Mounting Bolt, Flat & lock Washer, nylock nut, 1 set.

User Instructions

6514 & 6515 Vertical Ladder Stanchion Davit & Receptacle



Reliance Industries, LLC

Personal Fall Arrest Equipment Used with the Vertical Ladder Stanchion Receptacle & Davit

Care should also be used in selecting harnesses for use with the Vertical Ladder Stanchion Receptacle & Davit. Harnesses with sewn down back pads can limit as much as 1 ft. of back pad slippage during fall arrest, giving additional clearance for safety. If the system will be used where a worker could encounter a head first free-fall, a non-secured back pad can slide down the webbing to the small of the back, allowing the worker to fall out of the harness through the top by allowing the harness straps to slip over the shoulders. For this reason, we recommend the use of full body, crossover or pullover type harness with sewn down or slip resistant back pads for all installations.

Installation Layout Considerations

The Vertical Ladder Stanchion Receptacle & Davit is used to provide fall protection while climbing or descending ladders. The height of the Davit can be adjusted between 74-1/2" to 92-1/2" from the top rung of the ladder (see figure 2). The Davit should be adjusted for the maximum allowable height based on site geometry. Once at the new work level, provisions must be made for appropriate fall protection.

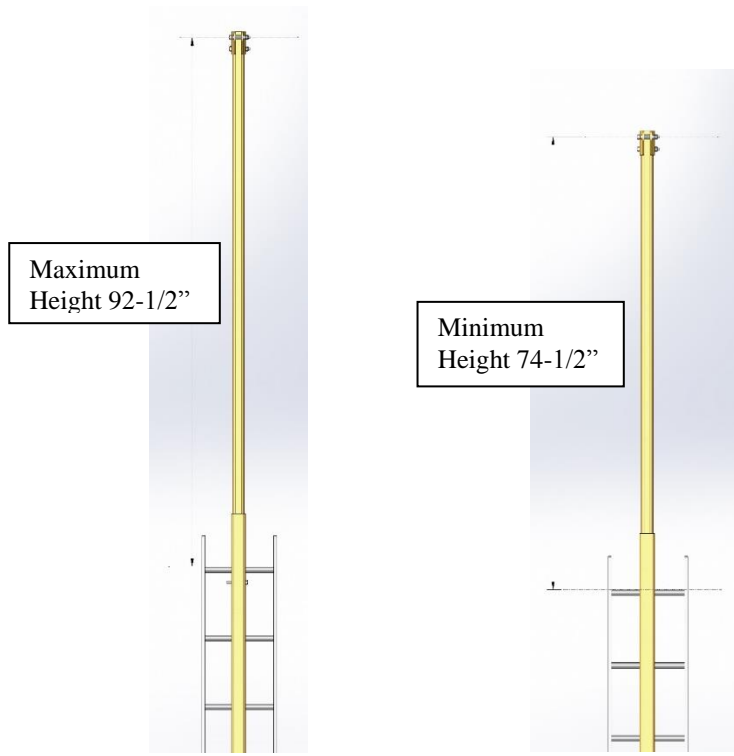

Fig. 2

User Instructions

6514 & 6515 Vertical Ladder Stanchion Davit & Receptacle



Reliance Industries, LLC

Installation

Note: Installation of the Vertical Ladder Stanchion Receptacle & Davit should be done under the supervision of a Competent Person. Approved fall protection MUST be worn at all times during installation of the Stanchion. Connection to the Stanchion Receptacle & Davit as an anchorage point for fall protection is not permitted until full installation has been completed and the Stanchion Receptacle & Davit has been inspected and certified for use. Only one 6514 and 6515 Ladder Stanchion Davit and Receptacle can be attached to any one ladder; connecting more than one Receptacle to a ladder at a time could exceed the rated strength of the ladder.

Vertical Ladder Stanchion Receptacle & Davit Installation Procedures

To Install the Vertical Ladder Stanchion Receptacle & Davit

1. Remove the 3 ea. rung clamps from the Stanchion Receptacle by removing the 6 sets of nuts and washers, and the 3 rung clamps from the 6 stud bolts welded to the Receptacle. (See Fig. 1 for parts identification).
2. Lift the Ladder Stanchion Receptacle into place on the front side of the ladder. Position the Stanchion Receptacle so that there is one bolt above the rung and one bolt below the rung for each of the 3 pairs of bolts. **NOTE:** The Ladder Stanchion Receptacle must be connected to 3 rungs; it cannot be used if connected to less than 3 rungs. The exposed ends of the bolts should be pointing towards the back of the ladder.
3. Place one of the Rung Clamps onto one pair of bolts to capture a rung. Secure in place with a flat washer, a lock washer, and a nylock nut. Tighten loosely, just enough to keep clamp from falling off. Repeat with the other 2 rung clamps.
4. Adjust the Ladder Stanchion Receptacle position to center it into the middle of the ladder rungs (see Fig. 3). **NOTE:** *In certain applications where ladder exit space is limited, the ladder can be offset to one side of the ladder. Since this offset mounting imparts a small amount of swing fall, care must be taken to ensure the offset placement does not put users at risk of hitting obstacles in the event of a swing fall.* Once placed, raise Stanchion Receptacle until ladder rung becomes captured in one of the v-shaped cuts in the rung clamp (see Fig. 4). **NOTE:** *It is preferred that the rungs be captured in the center v-cuts of the rung clamps, but it is not required. Because the spacing of rungs is often variable, not all 3 rungs will be in the same v-cut of the 3 clamps, try and raise or lower the stanchion receptacle and adjust the rung clamps until all three rungs become positioned into one of the v-cuts.*

User Instructions

6514 & 6515 Vertical Ladder Stanchion Davit & Receptacle



Reliance Industries, LLC

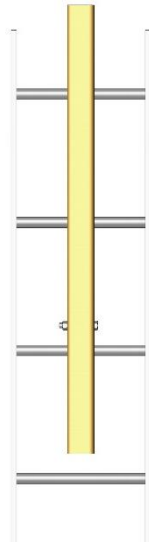

Fig. 3

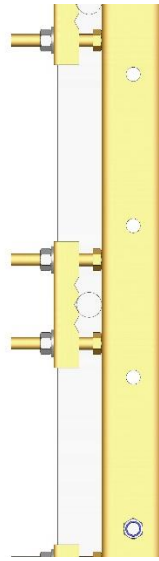

Fig. 4



Fig. 5

5. Tighten the nylock nuts onto the stud bolts after verifying that both the flat washer and lock washer are inserted under the nut, and that the stanchion is vertically centered on the ladder. Nuts should be tightened to 25- to 30-ft-lb. NOTE: Once torqued, the rung clamp will appear slightly bowed but not flattened or distorted; this is normal. The slight bowing of the clamp once torqued allows the rung clamp to better grip the rung.
6. Position the Davit mounting bolt, flat & lock washer, nylock nut, in the appropriate hole of the receptacle for optimal working height of the stanchion davit. Nut should be tightened to 25- to 30-ft-lb.
7. Insert the Stanchion Davit into the Receptacle until the end of the Davit contacts the Davit mounting bolt (see Fig. 5).
8. If it is not already installed, position the Head Sideplates onto the top of the Stanchion Davit tube with the Spacer bolt hole to the top (see Fig. 6). NOTE: The Spacer bolt hole should be pointed to the front of the ladder where the worker will be climbing or descending; if not, turn the sideplates so that it is pointing in the right direction. Secure in place with the 2 sideplate bolts and nuts.



Fig. 6

User Instructions

6514 & 6515 Vertical Ladder Stanchion Davit & Receptacle

Reliance Industries, LLC

9. If a bow shackle will be used to connect an SRL to the Ladder Stanchion, proceed to Step 8 without inserting the Spacer. If a carabiner is to be used to install an SRL to the Stanchion, the Spacer must be installed. To install the Spacer, slide the Head Spacer down between the two tips of the Head sideplate and align with the holes (see Fig. 7). Secure in place with the Spacer bolt and nut.

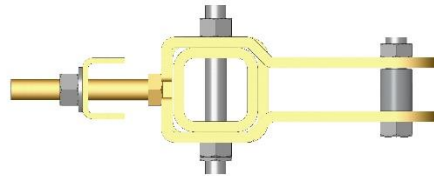

Fig. 7

Connecting an SRL to the Vertical Ladder Stanchion

10. Any SRL with a maximum arrest force of 900-lb. or less may be connected to the Vertical Ladder Stanchion using either a steel carabiner (part number 3062 or equivalent) or a 5/8-in. bow shackle (part number 6066; a 1/2-in. bow shackle is too small to connect an SRL to the Stanchion). To connect the SRL using a carabiner, pass the carabiner through the handle (or connection point) of the SRL and lift the SRL upward to the stanchion. While holding the carabiner gate open, slide the carabiner between the sideplates and onto the spacer. Allow the gate to close and lock (see Fig 8). NOTE: If a carabiner is used, the gate MUST close and lock once positioned onto the spacer. If the gate does not close and lock, a different, larger, carabiner must be used instead. If a bow shackle is used as the connection method for the SRL, the spacer and spacer bolt must be first removed. Connect the 5/8-in. bow shackle to the handle or connection point of the SRL and secure into place using the nut and the lock ring. Place the Spacer into the bow and hold into place while lifting in place. Raise the bow shackle/spacer and insert between the tips of the sideplates (see Fig. 9). Align the holes of the sideplates with the hole of the spacer and insert the spacer bolt. Secure in place with the nut and tighten.

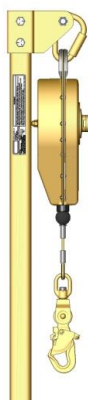

Fig. 8

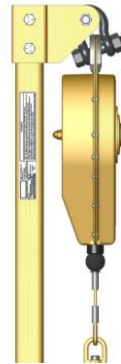

Fig. 9

User Instructions

6514 & 6515 Vertical Ladder Stanchion Davit & Receptacle



Reliance Industries, LLC

11. Check all fasteners for tightness and perform a function test/initial inspection of the SRL prior to certification of the Vertical Ladder Stanchion Receptacle & Davit for use.
12. Removal is the opposite of installation and must only be undertaken when no one is connected to the SRL. CAUTION: The SRL Must be removed from the Stanchion Davit before the Stanchion is removed from the Receptacle. Failure to remove the SRL from the Stanchion Davit before removing it from the Receptacle causes it to be extremely top heavy and unstable when removing it from the Receptacle, and seriously injuring individuals should it fall.

Training

It is the responsibility of the employer to train all workers prior to using this system (per OSHA 1926.503 (a)(1)). The employer shall provide a training program for each employee who might be exposed to fall hazards. The program shall enable each employee to recognize the hazards of falling and shall train each employee in the procedures to be followed in order to minimize these hazards.

The employer shall assure that, as necessary, each employee has been trained by a competent person qualified in the following areas:

- a. OSHA regulations governing the use of ladders and personal fall protection systems.
- b. Ability to recognize potential fall and workplace hazards.
- c. Method of inspection of safety equipment.
- d. Rescue procedures.
- e. Installation and removal techniques.

Planning for Rescue

Prior to system use, a rescue plan must be prepared, the workers must be trained in its use, and the rescue equipment must be on hand to implement it in case of a fall.

Typical rescue plans include (but are not limited to) the following items:

1. List of equipment that must be readily accessible in the event of an emergency and the names of those workers certified to use or operate that equipment.
2. Emergency contact phone numbers (ambulance, hospital, fire department...) and a means to contact them (cell phone, emergency radio).
3. List of employees on the site, and the specific tasks they will perform to effect the rescue.

Qualified Persons trained in fall protection planning and implementation should only undertake the design and installation of personal fall arrest systems. It is of the utmost importance to identify a method of rescue from deployed fall arrest systems after a fall has occurred, and have the means to effect the rescue on hand. In some situations it may be possible to use the fall arrest anchorage itself as an anchorage capable of use for rescue. However, in some situations, it is possible that access to



User Instructions

6514 & 6515 Vertical Ladder Stanchion Davit & Receptacle

Reliance Industries, LLC

the fallen individual will be blocked by other structure making it impossible to be used as a suitable anchorage for rescue. For this reason, always install rescue anchorages to rigid structures for attaching hoists or other retrieval equipment at locations that can be reached by rescue personnel. Note whether rescue must be up or down. If you rescue upward, anchorages must be high enough to raise the fallen worker above the walking/working surface. Individuals who will be using the Vertical Ladder Stanchion must be trained in the rescue plan and have the equipment on hand to implement it in an emergency. In case a worker has been injured or is unconscious, always consider the evacuation method and path to be used after the worker has been retrieved.

Contact Reliance Engineering for help in identifying possible methods of rescue and rescue planning.

Inspection

Prior to each use, the worker must inspect the system for any physical damage, wear, corrosion, or malfunctioning parts. If an inspection reveals a problem or unsafe condition, remove the entire system from service until it can be re-certified by a competent person.

Servicing

A qualified person trained in the inspection and servicing of system components must carry out servicing of this system. The company's safety officer should maintain a record log of all servicing and inspection dates. The system and all components must be withdrawn from service if subjected to fall arrest forces. Those components may be returned to service only after being re-certified by a qualified person. Only original Reliance equipment replacement parts are approved for use in this system. Contact Reliance Engineering with questions and when in need of assistance.

User Instructions

6514 & 6515 Vertical Ladder Stanchion Davit & Receptacle



Reliance Industries, LLC

Warnings and Limitations

Proper care should always be taken to visually scan the work area prior to use. Remove any obstruction, debris, and other materials from, and beneath the work area that could cause injuries or interfere with the operation of this system. Be cautious of swing fall hazards if working horizontally to the side of the Stanchion.

Users should be familiar with pertinent regulations governing the use of this system and its components. Only trained and competent personnel should install and supervise the use of this system.

Use only Reliance supplied or qualified compatible components.

**If you have any questions regarding the correct installation or use of this product DO NOT USE. Contact Reliance Engineering at
Ph. (303) 424-8650 or
Fax (303) 424-8670.**

User Instructions

6514 & 6515 Vertical Ladder Stanchion Davit & Receptacle



Reliance Industries, LLC

Inspection Log for the Vertical Ladder Stanchion

Company: _____ Location: _____ Date: _____
 Job Site: _____ Log No.: _____ System No.: _____

Describe non-conforming conditions in the boxes below:

Inspection Criteria	Missing Parts	Labels Readable	Corrosion	Deformed Parts	Cracked Parts/ Broken wires	Excessive Loading
Ladder intact/rungs not bent?						
Davit completely seated on Mounting Bolt?						
Receptacle centered on rungs?						
Alligator clamps tight on rungs (3 rung clamps)						
Stanchion head tight?						
Carabiner/bow shackle intact?						
SRL functioning/locking up?						
Receptacle attached to 3 rungs?						
Stanchion Davit proper height above Walking surface?						

Has a Rescue Plan been prepared? _____

Is Rescue Equipment on hand? _____

Have workers been trained in the Rescue Procedures and been given a copy of the Rescue Plan? _____