



## INSTRUCTIONS FOR USE

### **7000 Series Shock Absorbing Lanyards**

Complies with the current ANSI Z359.1-2007 and all applicable OSHA regulations and requirements.

Reliance Industries  
P.O. Box 2046  
Deer Park, TX 77536

Phone : 281-930-8000  
Toll Free : 888-362-282-6281  
Fax : 281-930-8666

## Contents

<b>DESCRIPTION</b>	<b>3</b>
<b>A. ATTACHMENT ELEMENTS (SNAP HOOKS AND WEB LOOPS)</b> .....	<b>4</b>
1) DORSAL ATTACHMENT .....	4
2) LANYARD LEG END SNAP HOOK, SINGLE LEG LANYARD .....	4
3) LANYARD LEG END SNAP HOOK, TWIN (TWO LEGGED) LANYARD	4
<b>B. BUCKLES AND ADJUSTERS</b> .....	<b>5</b>
1) LANYARD LENGTH ADJUSTERS .....	5
<b>C. LANYARD LEG MATERIALS</b> .....	<b>5</b>
1) 1" TATTLETALE <sup>™</sup> WEB .....	5
2) ELASTIC WEB .....	5
3) COATED KEVLAR <sup>®</sup> WEB .....	5
4) 1/4" VINYL COATED GALVANIZED CABLE .....	5
<b>D. OPTIONS</b> .....	<b>6</b>
<b>LANYARD APPLICATIONS AND SELECTION</b>	<b>6</b>
<b>A. PURPOSE</b> .....	<b>6</b>
1) PERSONAL FALL ARREST .....	6
2) WORK POSITIONING .....	7
3) RESTRAINT .....	8
4) RESCUE .....	8
<b>B. USE LIMITATIONS</b> .....	<b>8</b>
1) CAPACITY .....	8
2) FREE FALL .....	8
3) FALL CLEARANCE .....	8
4) SWING PENDULUM FALLS .....	10
5) CHEMICAL HAZARDS .....	10
6) HEAT .....	10
7) CORROSION .....	11
8) ELECTRICAL HAZARDS .....	11
9) MOVING MACHINERY .....	11
10) SHARP EDGES AND ABRASIVE SURFACES .....	11
11) WEAR AND DETERIORATION .....	11
12) IMPACT FORCES .....	11
<b>SYSTEMS REQUIREMENTS</b>	<b>12</b>
<b>A. COMPATIBILITY OF SYSTEM PARTS</b> .....	<b>12</b>
1) COMPATIBILITY OF COMPONENTS AND SUBSYSTEMS .....	12
2) COMPATIBILITY OF CONNECTORS .....	12
3) ANCHORAGES AND ANCHORAGE CONNECTORS .....	13
<b>USING THE LANYARD</b>	<b>14</b>
<b>A. INSPECT PRIOR TO USE</b> .....	<b>14</b>
<b>B. CONNECTING THE LANYARD</b> .....	<b>14</b>
<b>C. MAKING THE CONNECTION</b> .....	<b>14</b>
<b>D. PLAN SCOPE OF WORK TO BE PERFORMED ANALYSIS)</b> .....	<b>16</b>
<b>CARE OF THE LANYARD</b>	<b>17</b>
<b>INSPECTIONS</b>	<b>17</b>
<b>A. INSPECTION FREQUENCY</b> .....	<b>17</b>
<b>B. INSPECTION PROCEDURE</b> .....	<b>17</b>
<b>LABELING</b>	<b>18-19</b>
<b>INSPECTION RECORD</b>	<b>20</b>

# Instructions for Use

---

## User Instructions

### Reliance Shock Absorbing Lanyards

#### User Instruction Manual Shock Absorbing Lanyards

*This manual is intended to meet the Manufacturer's Instructions as required by the current ANSI Z359.1(2007) and EN355:2002, and should be used as part of an employee training program as required by OSHA.*

**WARNING:** *This product is one part of a personal fall arrest, restraint, work positioning, personnel riding, climbing, or rescue system. Without the other necessary components in such sub-systems the lanyard itself serves no useful purpose. The user must follow the manufacturer's instructions for each component of the system. These instructions must be provided to the user before using this product and retained for ready reference by the user. The user must read, understand (or have explained), and heed all instructions, labels, markings and warnings supplied with this product and with those products intended for use in association with it before using this equipment. Manufacturer's instructions must be followed for proper use and maintenance of this equipment. National standards and state, provincial and federal laws require the user to be trained before using this product. This manual can be used as part of a such a user safety-training program that is appropriate for the user's occupation.*

**IMPORTANT:** *Alterations or misuse of this product or failure to follow instructions may result in serious injury or death. If you have questions on the use, care, or suitability of this equipment for your application, contact RELIANCE Industries, LLC for information.*

## DESCRIPTION

Unless otherwise noted all Reliance lanyards are manufactured using certified 9600 pound (4355kg) rated Tattletale™ polyester webbing for superior inspectability and chemical and acidic tolerance. The maximum arresting force of Reliance energy absorbing lanyards and components is 900 pounds when dynamically tested in accordance with ANSI Z359.1 standards and 6kN when tested to EN355:2002.

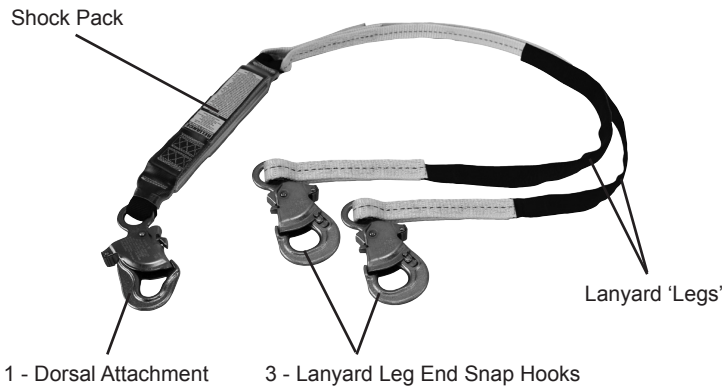

**Figure 1.**

The intended purpose of each element in the Lanyard is given in this subsection. For references see inspection diagram Figure 1.

### A. ATTACHMENT ELEMENTS (SNAPHOOKS & WEB LOOPS)

#### 1) DORSAL ATTACHMENT (QTY 1)

Pelican™ snap hook for attachment to the dorsal D-ring, also called back D-ring, present on all Harnesses. Shock absorbing lanyards should be attached ONLY to harness dorsal D-ring.

#### 2) LANYARD LEG END SNAP HOOK, SINGLE LEG LANYARD

For attachment to an anchorage element.

#### 3) LANYARD LEG END SNAP HOOK, TWIN (TWO LEGGED LANYARD)

Snap hook on the end of each lanyard leg, for attachment to an anchorage element.

## B. BUCKLES AND ADJUSTERS

### 1) LANYARD LENGTH ADJUSTERS

Buckle placed in the leg of a lanyard used to adjust the length of the lanyard.

## C. LANYARD LEG MATERIALS

### 1) 1" TATTLETALE™ WEB

The standard material on Reliance lanyards, a versatile polyester web with bright yellow jacket covering a "strength" core of bright red "tattletale" inner threads that make field inspection for cuts and abrasion easier and much more effective. Rated 9600 lb. (4355kg) breaking strength.

### 2) ELASTIC WEB

A 5000 lb (2268kg) web that will stretch to the standard 6' (1.8m) lanyard length on impact, but otherwise stays contracted at a 4-1/2' (1.4m) overall lanyard length. The reduced length of the lanyard reduces the possibility of the user accidentally tripping on the slack lanyard leg when walking or climbing.

### 3) COATED KEVLAR® WEB

Kevlar® Fiber woven into a 1-3/4" (45mm) web, then coated with a protective urethane coating to protect it from UV exposure. Kevlar® web is indicated for welders who need a lightweight material that is resistant to burns caused by weld spatter.

### 4) 1/4" COATED GALVANIZED CABLE

Constructed of vinyl coated 7x19 galvanized aircraft cable, for welders and workers in environments with welding spatter, abrasion or sharp edges that could damage fiber webbing.

**Nylon Rope** Before the advent of shock packs for lanyards nylon rope was used because its elastic qualities provided some shock absorption. This is not a desirable material today because when nylon rope stretches it will extend the overall length of a lanyard in the case of a fall. It also has relatively poor resistance to abrasion, will "birds nest" when twisted, and absorbs water and becomes swollen and heavy in wet conditions.

## **D. OPTIONS**

The following is a partial list of commonly used options and accessories (some options may not be available on all lanyards):

- STEELHEAD<sup>™</sup> Tieback hooks, for leg ends, allows tieback around an anchorage back onto a lanyard leg.
- Wear sleeves for web protection in harsh environments
- Web loops between shock pack and lanyard legs, permits replacement of worn lanyard legs.
- Kevlar<sup>®</sup> webbing
- High visibility webbing
- S/A Lanyard attached directly to D-ring or attachment element
- Lanyard Keepers (secures snap hook of lanyard out of the way when not in use)

## **LANYARD APPLICATIONS & SELECTION**

### **A. PURPOSE:**

RELIANCE lanyards are used as one component in a personal fall arrest system (PFAS). They may also be utilized in restraint, work positioning, or rescue systems when the appropriate attachments are present. Lanyards described in this manual meet, ANSI Z359.1, OSHA requirements (except where noted) and EN355:2002. These instructions, and markings borne by the lanyards, fulfill the instruction and marking requirements of those standards and regulations. This equipment is specifically designed to dissipate fall energy and limit the fall arrest forces that are transferred to the body.

#### **1) PERSONAL FALL ARREST:**

The shock absorbing lanyard is used as a component of a personal fall arrest system. Personal fall arrest systems typically include a full body harness, a connecting subsystem (energy absorbing lanyard) and an anchorage connector. Maximum arresting force must not exceed 1,800 lbs for ANSI Z359.1-(07) and OSHA. EN355:2002 limits max arresting force to 6kN.

# Instructions for Use

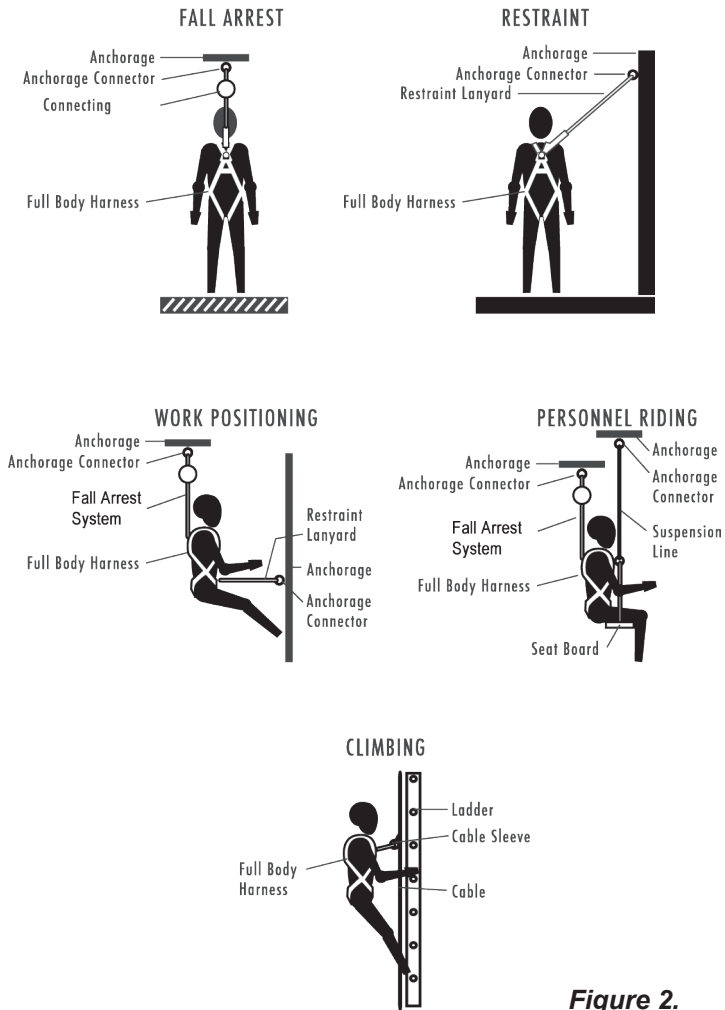

**Figure 2.**

## 2) WORK POSITIONING:

A lanyard is used as a component of a work positioning system to support the user at a work position (stabilize and partially support the user at an elevated work location and allow free use of both hands). Work positioning systems typically include a full body harness, positioning lanyard connected to an anchorage or anchorage connector, and a back-up personal fall arrest system, including a rope grab, S/A lanyard, or SRL.

### **3) RESTRAINT:**

A lanyard is used as a component of a restraint system to prevent the user from reaching a fall hazard (restricting the user's movement so as to prevent him from reaching a location where a fall hazard exists). Restraint systems typically include a full body harness, a lanyard or restraint line, and an anchorage or anchorage connection.

### **4) RESCUE:**

The lanyard is used as a component of a rescue system. Rescue systems are configured depending on the type of rescue.

## **B. USE LIMITATIONS:**

Consider the following application limitations before using this equipment:

### **1) CAPACITY:**

These lanyards are designed for use by persons with a combined weight (clothing, tools, etc.) of no more than 310 lbs. Persons with muscular, skeletal, or other physical disorders should consult a physician before using. Pregnant women and minors must never use the harness. Increasing age and diminished physical fitness may reduce a person's ability to withstand shock loads during fall arrest or prolonged suspension. Consult a physician if there is any question about a user's physical ability to safely use this product to arrest a fall or remain suspended. Models are available for persons with heavier combined weights (May also affect the selection of other components of a PFAS).

### **2) FREE FALL:**

Personal fall arrest systems used with this equipment must be rigged to limit the free fall to a maximum of 6' (1.8m)(ANSI Z359.1) or 5' (1.5m) (ANSI A10.14) and a fall factor 2 per EN355:2002. Restraint systems must be rigged so that no vertical free fall is possible. Work positioning systems must be rigged so that free fall is limited to 2' (.6m) or less. Rescue systems must be rigged so that no vertical free fall is possible. See subsystem manufacturer's instructions for more information.

### **3) FALL CLEARANCE:**

There must be sufficient clearance below the user to arrest a fall before the user strikes the ground or other obstruction. The clearance required is dependent on the following factors (see Figure 3. for reference):

- Elevation of anchorage
- Connecting subsystem length



# Instructions for Use

- Deceleration distance
- Free fall distance
- Worker height
- Movement of harness attachment element

## CALCULATE THE FALL CLEARANCE!

- 1. Determine the lanyard length:** Usually 6 ft
- 2. Add the maximum shock absorber extension:**  
Limited to 42" (3.5 ft) by regulations, so [6 ft + 3.5 ft = 9.5 ft]
- 3. Add the height of the anchorage above the user's feet:**  
If the anchorage is at shoulder height that is about 5 ft, [6 ft + 3.5 ft + 5 ft = 14.5 ft]
- 4. Add two feet as margin for error:**  
[6 ft + 3.5 ft + 5 ft + 2 ft = 16.5 ft]

The 16.5' (5m) is the total clearance distance required below the anchorage point, and the distance required below the walking/working surface is 11.5' (3.5m). For anchorage points that are located below the position of the dorsal (back) D-ring consider use of an adjustable-length lanyard to limit free-fall to less than 6' (1.8m), then re-calculate the fall clearance to ensure that the lanyard can be used safely. The standard adjustable-length lanyard can be adjusted from a 4.3' (1.3m) to a 6' (1.8) length.

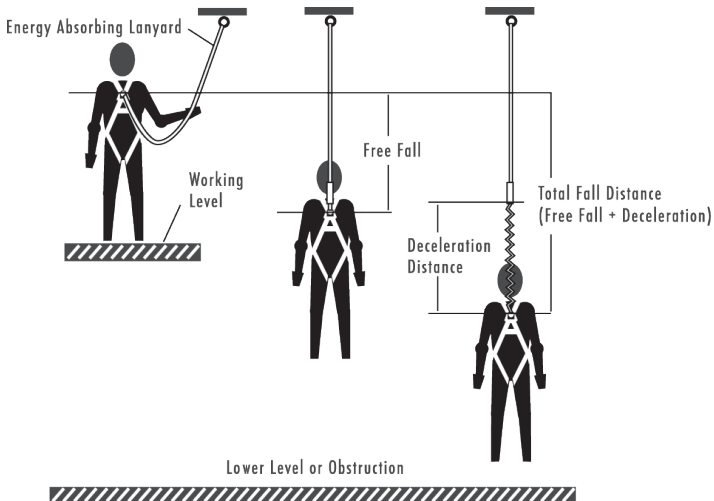
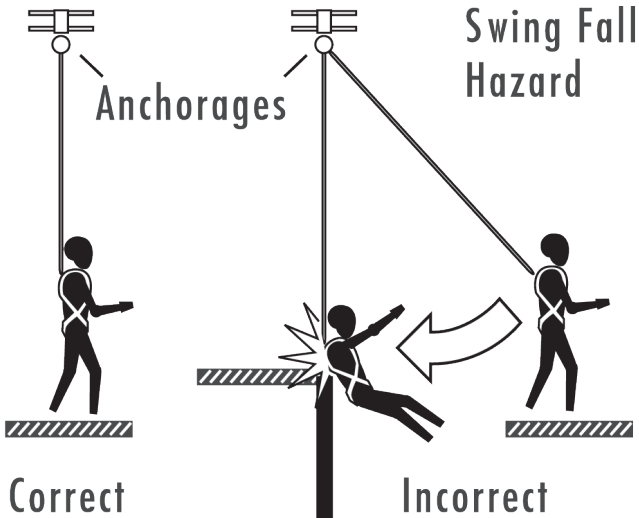

Figure 3.



*Figure 4.*

**4) SWING PENDULUM FALLS:**

Swing falls occur when the anchorage point is not directly above the point where a fall occurs. The force of striking an object in a swing fall may cause serious injury or death. Minimize swing falls by working as close to the anchorage point as possible (see Figure 4.). Do not permit a swing fall if injury could occur. Swing falls will significantly increase the clearance required when a self-retracting lifeline or other variable length connecting subsystem is used.

**5) CHEMICAL HAZARDS:**

Acidic, alkaline, or other environments with harsh substances may damage the webbing and hardware elements of this harness. Nylon is more resistant to degradation by alkaline or neutral pH environments. Polyester is more resistant to attack by acids. If working in a chemically aggressive environment, consult RELIANCE to determine which harness material is better for your specific conditions. When working in the presence of chemicals, more frequent inspection of the lanyard is required.

**6) HEAT:**

Do not use lanyard in environments with temperatures greater than 185°F (85°C). Protect the harness when used near welding, metal cutting, or other heat producing activities. Sparks may damage the harness webbing and reduce its strength. For high temperature

# Instructions for Use

---

applications (up to 700° F.) consider use of Kevlar® webbing.

**IMPORTANT:** *When working with tools, materials, or in high temperature environments, ensure that associated fall protection equipment can withstand high temperatures, or provide protection for those items.*

## **7) CORROSION:**

Do not expose harness to corrosive environments for prolonged periods. Organic substances and salt water are particularly corrosive to metal parts. When working in a corrosive environment more frequent inspection, cleaning, and drying of the lanyard is required. See Care of the Lanyard and Inspection sections cleaning and inspection details

## **8) ELECTRICAL HAZARDS:**

Use extreme caution when working near energized electrical sources. Metal hardware on the lanyard and on other components connected to it will conduct electric current. Maintain a safe working distance [preferably at least 10' (3m)] from electrical hazards.

## **9) MOVING MACHINERY:**

When working near moving machinery parts (e.g. conveyors, rotating shafts, presses, etc.), make sure that the lanyard legs are secured. Maintain a safe working distance from machinery that could entangle clothing, the lanyard, the harness, or other components connected to it.

## **10) SHARP EDGES AND ABRASIVE SURFACES:**

Do not expose lanyard leg straps to sharp edges or abrasive surfaces that could cut, tear or abrade and weaken the fibers. If working around sharp edges and abrasive surfaces is unavoidable use heavy padding or other protective barriers to prevent direct contact.

## **11) WEAR AND DETERIORATION:**

Any lanyard which shows signs of excessive wear, deterioration or aging, must be removed from use and marked "UNUSABLE" until destroyed. **See detailed inspection procedures.**

## **12) IMPACT FORCES:**

Any lanyard that has been subjected to the forces of arresting a fall must be immediately removed from service and marked as "UNUSABLE" until destroyed. RELIANCE lanyards have transparent shock pack covers that facilitate inspection for fall loading.



## SYSTEMS REQUIREMENTS

### A. COMPATIBILITY OF SYSTEM PARTS

#### 1) COMPATIBILITY OF COMPONENTS AND SUBSYSTEMS:

RELIANCE lanyards are designed to be used with RELIANCE approved components and connecting subsystems. Use of the lanyard with products made by others that are not approved in writing by RELIANCE may adversely affect the functional compatibility between system parts and the safety and reliability of the complete system. Connecting subsystems must be suitable for use in the application (e.g. fall arrest or restraint). RELIANCE produces a line of connecting subsystems for most applications. Contact RELIANCE for further information. Refer to the manufacturer's instructions supplied with the component or connecting subsystem to determine suitability. For fall arrest applications using the lanyard, the maximum free fall distance must not exceed 6' (1.8m). Contact RELIANCE with any questions regarding compatibility of equipment used with the lanyard.

#### 2) COMPATIBILITY OF CONNECTORS

Connectors, such as D-rings, snap hooks, and carabiners, must be rated at 5,000 lbf. (22 kN) minimum breaking strength. RELIANCE connectors meet this requirement. Connecting hardware must be compatible in size, shape, and strength. Non-compatible connectors may accidentally disengage ("rollout") or false engage. Always verify that the connecting snap hook or carabiner and the D-ring on the harness or anchorage connector is compatible. Use only self-closing, self-locking snap hooks and carabiners with the harness. Some harness models have web loop connection points. Do not use snap hooks to connect to web loops. Use a self-locking carabiner to connect to a web loop. Ensure the carabiner cannot cross-gate load (load against the gate rather than along the backbone of the carabiner). Some lanyards are designed to choke onto a web loop to provide a compatible connection. Connecting subsystems (self retracting lifeline, lanyard, rope grab and lifeline, cable grab, etc.) must be suitable for your application.

## Instructions for Use

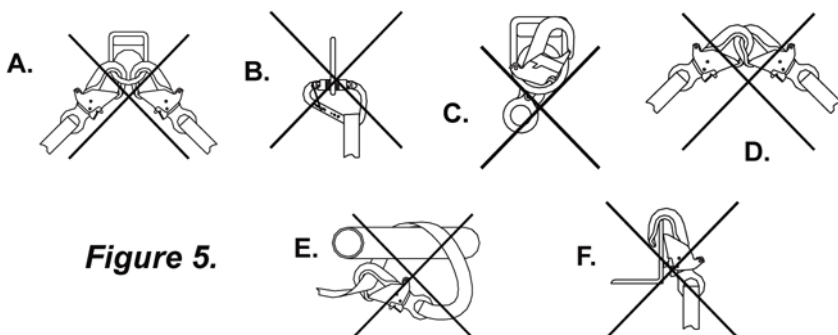

**Figure 5.**

### EXAMPLES OF INAPPROPRIATE CONNECTIONS (Figure 5.)

- A. To a D-ring to which another connector is attached.
- B. In a manner that would result in a load on the gate.
- C. In a false engagement, where features that protrude from the snap hook or carabiner catch on the anchor and seem to be fully engaged to the anchor point. (Reliance has designed the width of the head and gates of Reliance snap hooks to prevent this issue in most D-rings.)
- D. To each other.
- E. Directly to webbing or rope lanyard or tie-back (unless the manufacturer's instructions for both the lanyard and connector specifically allow such a connection. See Reliance Steelhead™ snap for this purpose)
- F. To any object which is shaped or dimensioned so that the snap hook or carabiner will not close and lock, or that could cause roll-out should a fall occur.

### 3) ANCHORAGES AND ANCHORAGE CONNECTORS

Anchorage for personal fall arrest systems must have a strength capable of supporting a static load, applied in directions permitted by the system, of at least: (a) 3,600 lbf. (16 kN) when certification exists, or (b) 5,000 lbf. (22.2 kN) in the absence of certification. When more than one personal fall arrest system is attached to an anchorage, the anchorage strengths set forth in (a) and (b) must be multiplied by the number of systems attached to the anchorage. This requirement is consistent with OSHA requirements under 29 CFR 1910, Subpart F, Section 1910.66, Appendix C. Anchorages for work positioning or restraint must have strength capable of supporting a static load, applied in the directions permitted by the system of at least 3,000

lbs., or twice the potential impact load as ascertained by a qualified person, whichever is greater. See OSHA 1926.502. When more than one work positioning system is attached to a rigid anchorage, the strengths stated above must be multiplied by the number of work positioning systems attached to the anchorage.

## USING THE LANYARD

### A. INSPECT PRIOR TO USE:

Before the use of this lanyard, inspect the lanyard and all components of the PFAS:

- 1) Inspect the lanyard to verify that it is in serviceable condition. Examine every inch of the lanyard straps for severe wear, cuts, burns, frayed edges, abrasion, or other damage. Examine stitching for any pulled, loose, or torn stitches. See Inspection section for details. *Do not use lanyard if inspection reveals an unsafe condition. Always err on the side of safety*

### B. CONNECTING THE LANYARD

- 1) With the lanyard dorsal connector snap hook (hook nearest the shock pack) in one hand reach around with the other hand at belt level to grasp the dorsal D-ring on the harness.
- 2) With the hand securing the hook open the gate and reach behind the back (also at belt level) and up to catch the dorsal D-ring of the harness with the hook, then release the gate mechanism.
- 3) Release the hook and D-ring, then give the lanyard several sharp tugs to verify that the hook has correctly engaged the D-ring. Detach the lanyard from the harness in reverse order.

### C. MAKING THE CONNECTION

Attaching a Tie-Back Lanyard. Use ONLY a lanyard equipped with Reliance STEELHEAD<sup>™</sup> tie-back hooks when attaching the snap back to the lanyard. Place the tie-back lanyard over the anchoring structure, giving consideration to the effect that sharp edges or narrow radius could have on the anchorage strength. Ensure that the lanyard is not twisted and that the Steelhead<sup>™</sup> snap is positioned so as not to load the gate on the structure.

# Instructions for Use

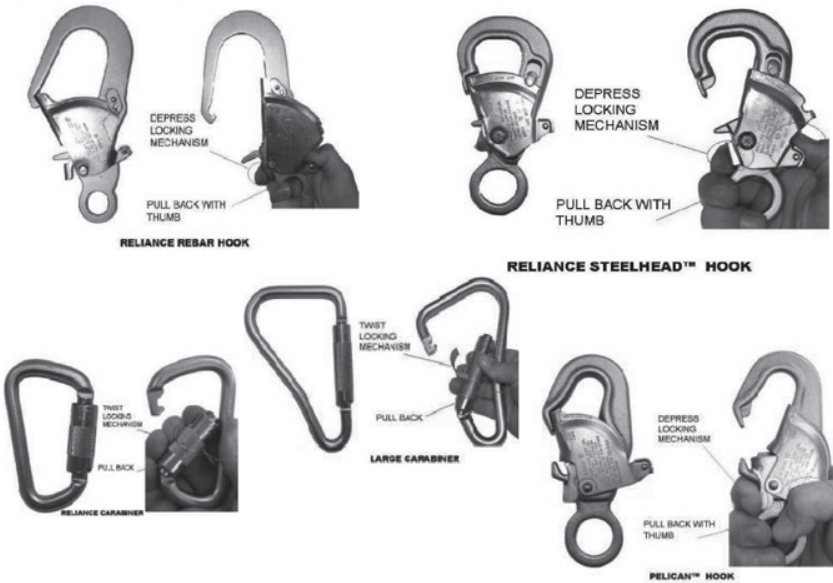

## Attaching a Lanyard with a Web Loop Connection (Figure 8):

- 1) Insert the energy absorbing lanyard web through the harness web loop or D-ring.
- 2) Insert the opposite end of the energy absorbing lanyard through the connecting web loop.
- 3) Pull the attached energy absorbing lanyard through the connecting web loop to secure.

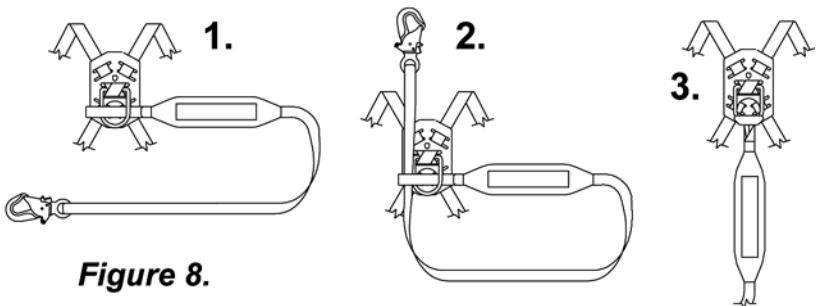

**Figure 8.**

**CONNECTING TO A ROPE GRAB (FALL ARRESTOR):**

NEVER connect a standard 6' (1.8m) length lanyard to a rope grab. In all cases ensure that the length of the energy absorber or energy absorbing lanyard does not exceed the maximum connector length recommended by the rope grab manufacturer or 3' (.9m) maximum per ANSI Z359.1 It is recommended that the lanyard leg end and not the shock absorber end be connected to the rope grab. This recommendation is intended to eliminate the possibility of interference with the operation of the rope grab by the energy absorber "pack". Some rope grabs may be supplied with a permanently attached energy absorbing lanyard.

**CONNECTING TO A SRL (Self Retracting Lifeline)**

NEVER connect an energy absorbing lanyard or other energy absorber to a self-retracting lifeline. There are some very special applications where such a combination may be possible, but such connections should be made ONLY after consultation with Reliance.

**D. PLAN SCOPE OF WORK TO BE PERFORMED (JOB SAFETY TASK ANALYSIS)**

Plan procedures to safely perform tasks when using any components of a PFAS. Some considerations are listed below (see APPLICATIONS, item B. USE LIMITATIONS section for additional details);

- 1) Anchorage Selection. In addition to strength considerations, the anchorage should be rigged to prevent a fall onto the structure when considering 2) and 4) below.
- 2) Swing pendulum fall
- 3) Rough surfaces or unprotected sharp edges that could cut or abrade the equipment if unprotected.
- 4) Workplace geometry
  - a) Free fall distance- Limited to 6' (1.8m) by OSHA and ANSI Z359.1. Limited to a fall factor 2 of the lanyard length per EN355:2002.
  - b) Deceleration distance. Maximum 3.5 ft (See B. Use Limitations).
  - c) Total fall distance. The sum of the free fall distance and deceleration distance plus a 3.3' (1m) safety margin.
- 5) Rescue and Evacuation - The user and employer must have a rescue plan in place, training in its use, and the means to implement it at hand. The employer must have the ability to perform a rescue quickly and safely. Do not plan to rely on others for rescue because prolonged suspension can cause bodily injury or death.



# Instructions for Use

---

## CARE OF THE LANYARD

- A. Clean lanyard with luke-warm water and a mild laundry detergent solution. Do not use bleach or bleach solutions. Dry hardware with a clean, dry cloth, and hang to air dry. Do not force wash or dry with heat in laundry machines. Do not attempt to disassemble the unit. A buildup of dirt, solvents, paint, etc. may prevent the lanyard from working properly, and in severe cases degrade the webbing to a point where it weakens and should be removed from service. More information on cleaning is available from RELIANCE. If you have questions concerning the condition of your lanyard, or have any doubt about putting it into service contact RELIANCE.
- B. Store lanyards in a cool, dry, clean environment out of direct sunlight. Avoid areas where heat, oil, chemicals or their vapors may exist. Thoroughly inspect the full body harness after extended storage. Good safety practice requires separate storage of unusable product from usable product.

## INSPECTIONS

### A. INSPECTION FREQUENCY

- 1) The lanyard must be inspected by the user prior to each use.
- 2) A competent person other than the user must inspect the lanyard thoroughly at least annually. ***Extreme working conditions (harsh environments that might degrade the webbing or corrode the hardware, prolonged use, etc.) may require increasing the frequency of inspections.*** Record the results of each formal inspection in the inspection and maintenance log as described below.

### B. INSPECTION PROCEDURE

- 1) Inspect all webbing (straps) and stitching for cuts, fraying, pulled or broken threads, abrasion, excessive wear, altered or missing straps, burns, and heat and chemical degradation. Broken stitches or separation of webbing inside the lanyard shock pack could indicate that the lanyard has been impact loaded and must be removed from service. This should be readily observable through the clear cover of the shock absorbing pack.  
Observe the “Tattletale™” carrier ply webbing for surface areas with the brightly contrasting red colored yarns (or sometimes other brightly contrasting colors, depending the color of the outside web),

indicating that excessive abrasion has occurred. For more details on the Tattletale™ webbing as an inspection tool, contact RELIANCE.

- 2) Inspect all metallic hardware (i.e. D-rings, adjuster/buckles) for deformation, fractures, cracks, corrosion, deep pitting, burrs, sharp edges, cuts, deep nicks, missing or loose parts, improper function, and evidence of excessive heat, chemical, or electrical exposures. Ensure snap hook gates work & mate freely.
- 3) All labels should be present and fully legible. See figures of labels on following page. Record the inspection on the label area by punching a hole or marking. The back page of this booklet contains an independent inspection log that should be maintained in conjunction with the inspection label on the harness to ensure that 1) the inspections have been performed on a regularly scheduled basis and 2) the inspection log will not become lost or misplaced. RELIANCE will be happy to provide additional forms or suggest other methods of electronically documenting this process.
- 4) Verify each component or subsystem of the complete PFAS are inspected according with the associated manufacturer's instructions.
- 5) If inspection reveals a defective condition or improper maintenance remove unit from service immediately and destroy or label it as "UNUSABLE" until formal inspection by competent person. Defects, damage, excessive wear and/or aging are generally not repairable. Only RELIANCE or parties with written authorization from RELIANCE may make repairs to the lanyard.

## LABELING

The illustrations on the following pages are representations of the actual labels that appear on Reliance lanyards.

The **Lanyard Warnings Label** contains general warnings and is intended to be an assistance to the user, but is not a substitute for user training in the use of the product and the detailed warnings, cautions and instructions that are contained in this booklet.

The **Lanyard Specifications Label** contains information that is specific to the particular lanyard. It will identify the RELIANCE part number, lanyard length and material, the date of manufacture, and the Lanyard's unique serial number in both text and UPC barcode form. The barcodes are intended to facilitate the issuance, inspection and logging procedures for those users equipped to utilize bar codes.

# Instructions for Use

All the information on the Lanyard Specifications Label is important for the safe use of this product, so the user should ensure that the label has not been removed and that the descriptions it contains match the task and environment in which the product is intended to be used. The Lanyard inspection log is found on the Lanyard Specifications Label. The log can be marked with an indelible marker or punched on the occasion of inspections. A Competent Person will verify this label at least annually, more often in the case of heavy use.

UPC Inventory / Mfg Code / Model No.												
 83325200 XXXXXX												
Model XXXXXX												
Size 6 Ft.												
Date Mfg Jan XX, XXXX												
Material Polyester												
Serial No.												
 XXXXXX												
FIRST USE / INSPECTION LOG												
2002	1	2	3	4	5	6	7	8	9	10	11	12
2003												
2004												
2005												
2006												

## Lanyard Label for EN355

**RELIANCE**

PO Box 2046 Deer Park, TX 77598  
 Phone 888-362-2926 / 281-933-9920  
 www.reliance.com

**Shock Absorbing Lanyard**  
 Max Capacity: 310 lb  
 Max Arresting Force: 900 lbs.  
 Meets: ANSI Z359.1 (07) / ANSI A10.32(04) & OSHA Standards  
 Length: 6 ft max.  
 Material Construction: Polyester

**Warnings!**

You must read and understand all instructions supplied with this product at the time of shipment. If you need a copy, contact Reliance. Failure to do so may result in injury or death. This product must be inspected prior to each use and at regular scheduled intervals. This product must be used with a full body harness. This lanyard may elongate as much as 42" in a free fall arrest. Care must be observed when selecting proper anchor points to avoid swing fall hazards and an adequate clearance of 16" minimum. Unless specified, this product is not flame or heat resistant and has a maximum user weight of 310 lbs including tools. Although this lanyard is designed for work environments, avoid exposure to sharp or rough edges and materials. For lanyards with two integrally connected legs, attach only the snaphook at the center of the lanyard to the fall arrest attachment element of the harness. Ensure that snap hooks and other connectors are compatible to reduce possibility of roll-out. Training in proper use and limitations of fall protection systems and equipment is required prior to use. Remove immediately from use any equipment that has been subjected to an impact load. An appropriate rescue/evacuation plan must be in place before using this product.

**MADE IN THE USA**  
 T3022000

**ANSI S/A Lanyard Warnings Label**  
 (Located on shock pack, under protective PVC sleeve)



# Instructions for Use

## These Instructions Apply to the Following Part Numbers :

711002	719010	731126	737104	741476	747406
711003	719012	731153	737106	741486	747496
711005	721001	731204	737108	741496	747606
711006	721102	731206	737110	741506	747706
711103	722000	731276	737112	741586	747806
711104	722001	731406	737206	741606	747906
711106	724305	731407	737406	741615	749406
711109	726000	731456	737496	741616	751106
711116	726001	731503	739100	741626	751206
711118	726002	731586	739126	741636	751406
711202	726003	731593	739406	741646	751706
711203	726010	731622	739900	741700	761106
711206	730104	731623	740106	741706	761126
711212	730106	731626	740206	741720	761126STAR
711302	730206	731633	741000	741796	761206
711912	731100	731700	74102.5	741804	761406
711954	731101.2	731790	741102	741806	761426
711955	731102	731793	741103	741886	761446
713106	731102.6	731900-A	741104	741900	761606
713206	731102.8	731900-C	741105	741926	761806
715106	731103	731956	741106	741936	767106
715110	731103.1	731996	741108	741946	767206
717102	731103.5	732100	741116	741999	767406
717103	731103.6	732101	741125	742106	
717106	731104	732102	741126	742206	
717108	731104.8	732103	741126STAR	743406	
717110	731105	732106	741136	744104	
717118	731105.5	732206	741204	744105	
717206	731105.6	732501	741226	744106	
717406	731106	732636	741276	744206	
717412	731106.3	732990	741286	744406	
717608	731107	734104	741336	744700	
717901	731107.2	734106	741406	745106	
717903	731107.5	734206	741406A	745206	
717906	731108	734406	741423	745216	
717912	731108.9	734408	741426	745806	
718106	731109.2	734700	741436	747106	
718806	731109.3	735106	741446	747112	
719006	731110	735206	741456	747204	
719008	731111	737103	741466	747206	



**Reliance Industries**  
**P.O. Box 2046**  
**Deer Park, TX 77536**  
**Phone : 281-930-8000**  
**Toll Free : 888-362-282-6281**  
**Fax : 281-930-8666**  
**[www.relsafe.com](http://www.relsafe.com)**